

DVC153

DC/DC converter

DC/DC converter for vehicles and other applications



Abbildung ähnlich / device similar to figure



DVC153 - derivate table

Type	Input voltage	Output voltage	Output current	Cat. No.
	Nom. (Tol.)	Nom.	Max.	
DVC153-24/36-12	36VDC (19 - 47VDC)	12,5VDC	12A	105173/x/000
DVC153-48-12	48VDC (34 - 62VDC)	12,5VDC	12A	105174/x/000
DVC153-80-12	80VDC (62 - 104VDC)	12,5VDC	12A	105175/x/000
DVC153-80-13,8	80VDC (62 - 104VDC)	13,8VDC	11A	105169/x/000

*Order option:

.../x/...: Accessory variant

.../0/...without accessory

.../20/... with heatsink

More on request

DC/DC converter

DVC153

Alle Daten gemessen bei 36, 48, 80VDC, 11, 12A und 25°C Umgebungstemperatur, wenn nicht anders gekennzeichnet. | All parameters are specified at 36, 48, 80VDC, 11, 12A and 25°C ambient, if not marked otherwise.
 Technische Änderungen und Irrtümer vorbehalten. | Technical modifications and mistakes reserved.

Mit den Angaben im Katalog und in den Datenblättern werden Produkte beschrieben, nicht Eigenschaften zugesichert. Belastung mit „Grenzwerten“ (einfache Kombination) ist zulässig ohne bleibende Schäden der Produkte. Betrieb der Geräte mit Grenzwertbelastung für längere Zeit kann die Zuverlässigkeit beeinträchtigen. Grenzwerttoleranzen unterliegen üblichen Schwankungen. | Products are described by information contained in catalogs and data-sheets. It is not be considered as assured qualities. Stresses listed under „Maximum Rating“ (one at a time) may be applied to devices without resulting in permanent damage. The operation of the equipment for extended periods may affect device reliability. Limiting value tolerance are subject to usual fluctuation margins.

1 Input

Input voltage range	-	see DVC153 - derivate table (valid for continuous operation)
Undervoltage range (Class C*)	0 - 17 VDC 0 - 24 VDC 0 - 45 VDC	DVC153-24/36-12 DVC153-48-12 DVC153-80-12 / DVC153-80 -13,8
Lower restricted operation range (Continuous operation, class B*)	17 - 19 VDC 24 - 34 VDC 45 - 62 VDC	DVC153-24/36-12 DVC153-48-12 DVC153-80-12 / DVC153-80 -13,8
Unrestricted operation range (Continuous operation, class A*)	19 - 47 VDC 34 - 62 VDC 62 - 104 VDC	DVC153-24/36-12 DVC153-48-12 DVC153-80-12 / DVC153-80 -13,8
Upper restricted operation range (≤ 5 s, Class B*)	47 - 51 VDC 62 - 67 VDC 104 - 112 VDC	DVC153-24/36-12 DVC153-48-12 DVC153-80-12 / DVC153-80 -13,8
Overvoltage range (≤ 100 ms, Class B*)	51 - 54 VDC 67 - 72 VDC 112 - 120 VDC	DVC153-24/36-12 DVC153-48-12 DVC153-80-12 / DVC153-80 -13,8
Start up delay	typ. 75 ms (36VDC) typ. 90 ms (48VDC) typ. 270 ms (80VDC) typ. 160 ms (80VDC)	DVC153-24/36-12 DVC153-48-12 DVC153-80-12 DVC153-80 -13,8 Time from applying the input voltage until the output voltage is statically within the permissible tolerances.
Input capacity	< 20 µF < 15 µF < 10 µF	DVC153-24/36-12 DVC153-48-12 DVC153-80-12 / DVC153-80 -13,8 Attention: No inrush current limitation in the device. Provide a precharging section in the application, otherwise there is a risk of a overvoltage damage to the input of the DC/DC converter.
No-load input power	typ. 1,9 W (36 VDC) typ. 2,3 W (48 VDC) typ. 2,6 W (80 VDC) typ. 2,8 W (80 VDC)	DVC153-24/36-12 DVC153-48-12 DVC153-80-12 DVC153-80 -13,8 see fig. 9.1
No-load current consumption	typ. 55 mA (36 VDC) typ. 48 mA (48 VDC) typ. 35 mA (80 VDC) typ. 42 mA (80 VDC)	DVC153-24/36-12 DVC153-48-12 DVC153-80-12 DVC153-80 -13,8 see fig. 9.2
Current consumption at full load	typ. 4,7 A (36 VDC) typ. 3,5 A (48 VDC) typ. 2,1 A (80 VDC) typ. 2,1 A (80 VDC)	DVC153-24/36-12 DVC153-48-12 DVC153-80-12 DVC153-80 -13,8 see fig. 9.3

DC/DC converter

DVC153

Alle Daten gemessen bei 36, 48, 80VDC, 11, 12A und 25°C Umgebungstemperatur, wenn nicht anders gekennzeichnet. | All parameters are specified at 36, 48, 80VDC, 11, 12A and 25°C ambient, if not marked otherwise.
 Technische Änderungen und Irrtümer vorbehalten. | Technical modifications and mistakes reserved.

Mit den Angaben im Katalog und in den Datenblättern werden Produkte beschrieben, nicht Eigenschaften zugesichert. Belastung mit „Grenzwerten“ (einfache Kombination) ist zulässig ohne bleibende Schäden der Produkte. Betrieb der Geräte mit Grenzwertbelastung für längere Zeit kann die Zuverlässigkeit beeinträchtigen. Grenzwerttoleranzen unterliegen üblichen Schwankungen. | Products are described by information contained in catalogs and data-sheets. It is not be considered as assured qualities. Stresses listed under „Maximum Rating“(one at a time) may be applied to devices without resulting in permanent damage. The operation of the equipment for extended periods may affect device reliability. Limiting value tolerance are subject to usual fluctuation margins.

* Evaluation criteria for the operation behavior

The following evaluation criteria describe the functional state of the DC/DC converter as a function of the operation input voltage.

Class A	Unrestricted operation range	The DC/DC converter operates as designed in compliance with the tolerances specified in the data sheet.
Class B	Lower and upper restricted operation range	One or more functions may go beyond the specified tolerance. After returning to the unrestricted operation range, the DC/DC converter operates again as designed.
Class C	Undervoltage and overvoltage range	One or more functions do not work as intended. After returning to the unrestricted operation range, the DC/DC converter operates again as designed.

2 Output

Output voltage U_{nom}	12,5 VDC 13,8 VDC	@ $U_{IN,nom}$, $I_{OUT} = 6 A$ @ $U_{IN,nom}$, $I_{OUT} = 5,5 A$
Initial tolerance $N_{initial}$	+0,4% / - 0,6% U_{nom}	see fig. 9.8 and fig. 9.9
Input regulation tolerance N_{input}	$\pm 0,2\% U_{nom}$	-
Load regulation tolerance N_{load}	+1,5% / - 1,7% U_{nom}	-
Ripple & Noise N_{RN}	$\pm 0,65\% U_{nom}$	$U_{RN} \leq 180 mV_{pp}$, measurement bandwidth 20 MHz
Overall tolerance $N_{overall}$ (0-20 Hz)	+2,1% / - 2,5% U_{nom}	$N_{overall} = N_{initial} + N_{input} + N_{load}$ Value represents worst case scenario for a bandwidth from 0 Hz up to 20 Hz.
Overall tolerance $N_{overall}$ (0-20 MHz)	+2,75% / - 3,15% U_{nom}	$N_{overall} = N_{initial} + N_{input} + N_{load} + N_{RN}$ Value represents worst case scenario for a bandwidth from 0 Hz up to 20 MHz.
Continuous output current I_{nom}	$\leq 12 A$ $\leq 11 A$	DVC153-XX-12 DVC153-80-13,8
Max. output power $P_{out,max}$	150 W	-
Current limiting	$< 1,1 \times I_{nom}$	from $1,0 \times I_{nom}$ U_{out} may sink
Recovery time	$< 3 ms$	Duration from leaving the overall tolerance until the permanently return to the tolerance band after a load step. (at $\frac{dI}{dt} < 1 A/\mu s$)

DC/DC converter

DVC153

Alle Daten gemessen bei 36, 48, 80VDC, 11, 12A und 25°C Umgebungstemperatur, wenn nicht anders gekennzeichnet. | All parameters are specified at 36, 48, 80VDC, 11, 12A and 25°C ambient, if not marked otherwise.
 Technische Änderungen und Irrtümer vorbehalten. | Technical modifications and mistakes reserved.

Mit den Angaben im Katalog und in den Datenblättern werden Produkte beschrieben, nicht Eigenschaften zugesichert. Belastung mit „Grenzwerten“ (einfache Kombination) ist zulässig ohne bleibende Schäden der Produkte. Betrieb der Geräte mit Grenzwertbelastung für längere Zeit kann die Zuverlässigkeit beeinträchtigen. Grenzwerttoleranzen unterliegen üblichen Schwankungen. | Products are described by information contained in catalogs and data-sheets. It is not be considered as assured qualities. Stresses listed under „Maximum Rating“ (one at a time) may be applied to devices without resulting in permanent damage. The operation of the equipment for extended periods may affect device reliability. Limiting value tolerance are subject to usual fluctuation margins.

3 Environment

Working temperature (environment)	-25°C ... +50°C	-
Max. permissible temperature of the mounting surface	< +50°C	-
Overtemperature protection	approx. 95°C	Protective shutdown with self-reset. Measured at the temperature reference point.
Storage temperature	-40°C ... +85°C	-
Humidity	95%	-
Dewing	allowed	-
Shock test acc. to DIN EN 60068-2-27	-	half sinusoidal (Excitation) 250m/s ² (Peak acceleration) 6ms (Duration) 3.000 shocks to each axis (Quantity) ±X, ±Y, ±Z (Axis)
Vibration test acc. to DIN EN 60068-2-6	-	sinusoidal (Excitation) 30m/s ² (acceleration) 10 - 500Hz (frequency, floating) 2h per axis (Duration), 1 Oct/min X, Y, Z (Axis)
Degree of protection acc. to EN 60529	IP65	-

4 General data

Insulation strength	1,2 kV _{RMS} 1,2 kV _{RMS}	Input / Output and enclosure Output / Enclosure
Max. efficiency	typ. 90% (36 VDC) typ. 90,5% (48 VDC) typ. 91% (80 VDC) typ. 91% (80 VDC)	DVC153-24/36-12 DVC153-48-12 DVC153-80-12 DVC153-80-13,8 see fig. 9.5
Average efficiency	typ. 89% (36 VDC) typ. 89,5% (48 VDC) typ. 89,5% (80 VDC) typ. 90% (80 VDC)	DVC153-24/36-12 DVC153-48-12 DVC153-80-12 DVC153-80-13,8 Averaging of the efficiency values at 25%, 50%, 75% und 100% of the nominal output power. see fig. 9.6
Dimensions (LxWxH)	ca. (180 x 85 x 46,5)mm ca. (180 x 85 x 23,5)mm	with connections see fig. 8.1 without connections see fig. 8.1
Enclosure	Aluminium	-
Weight	approx. 700g	-

DC/DC converter

DVC153

Alle Daten gemessen bei 36, 48, 80VDC, 11, 12A und 25°C Umgebungstemperatur, wenn nicht anders gekennzeichnet. | All parameters are specified at 36, 48, 80VDC, 11, 12A and 25°C ambient, if not marked otherwise.
 Technische Änderungen und Irrtümer vorbehalten. | Technical modifications and mistakes reserved.

Mit den Angaben im Katalog und in den Datenblättern werden Produkte beschrieben, nicht Eigenschaften zugesichert. Belastung mit „Grenzwerten“ (einfache Kombination) ist zulässig ohne bleibende Schäden der Produkte. Betrieb der Geräte mit Grenzwertbelastung für längere Zeit kann die Zuverlässigkeit beeinträchtigen. Grenzwerttoleranzen unterliegen üblichen Schwankungen. | Products are described by information contained in catalogs and data-sheets. It is not be considered as assured qualities. Stresses listed under „Maximum Rating“ (one at a time) may be applied to devices without resulting in permanent damage. The operation of the equipment for extended periods may affect device reliability. Limiting value tolerance are subject to usual fluctuation margins.

5 Standards

EMC (Electromagnetic Compatibility)

Title	Standard	Data
Emitted interference	EN 12895	-
Immunity	ECE R10.5 EN12895 EN 61204-3	- - acc. to 7.2.3, Noise immunity level for industrial environment (cable length < 3 m)

Electrical safety

Title	Standard	Data
Low-voltage switch mode power supplies - Safety requirements	DIN EN 61204-7	-
Safety of industrial trucks - Electrical requirements	designed according to DIN EN 1175*	-

* The system integrator is responsible for compliance of all product-specific requirements in the end application.

6 Installation and safety instructions

In addition to the general installation and safety instructions for DC/DC converters, the following values and supplements apply:

Mounting points	-	4x Mounting holes (Ø9 mm) see fig. 8.1
Installation orientation	-	any
Connection input / output	-	see fig. 7.1
Input fuse	-	No integrated input fuse. A fuse must be provided externally by the customer application.
Reverse polarity protection	-	No reverse polarity protection integrated at the input or output of the device. Reverse polarity protection is ensured exclusively by the plug connector. If the polarity is reversed at the input, then the input fuse to be connected in series will trip.

The general installation and safety instructions for DC/DC converters can be found at: www.deutronic.com

DC/DC converter

DVC153

Alle Daten gemessen bei 36, 48, 80VDC, 11, 12A und 25°C Umgebungstemperatur, wenn nicht anders gekennzeichnet. | All parameters are specified at 36, 48, 80VDC, 11, 12A and 25°C ambient, if not marked otherwise.
Technische Änderungen und Irrtümer vorbehalten. | Technical modifications and mistakes reserved.

Mit den Angaben im Katalog und in den Datenblättern werden Produkte beschrieben, nicht Eigenschaften zugesichert. Belastung mit „Grenzwerten“ (einfache Kombination) ist zulässig ohne bleibende Schäden der Produkte. Betrieb der Geräte mit Grenzwertbelastung für längere Zeit kann die Zuverlässigkeit beeinträchtigen. Grenzwerttoleranzen unterliegen üblichen Schwankungen. | Products are described by information contained in catalogs and data-sheets. It is not be considered as assured qualities. Stresses listed under „Maximum Rating“ (one at a time) may be applied to devices without resulting in permanent damage. The operation of the equipment for extended periods may affect device reliability. Limiting value tolerance are subject to usual fluctuation margins.

7 Connections

Input / Output

TE Connectivity 1-929180-1, 6-pole:

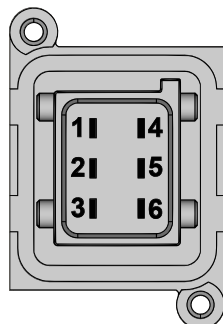

PIN "1": not assigned
 PIN "2": not assigned
 PIN "3": $V_{IN, +}$
 PIN "4": $V_{OUT, +}$
 PIN "5": $V_{OUT, -}$
 PIN "6": $V_{IN, -}$

- Suitable mating connector TE Connectivity 1-963212-1
- Connection cross section at mating connector min. 1,5 mm²
- max. number of mating cycles: 10
- Individual connection technology on customer request for input and output possible

Figure 7.1: Pin - Assignment

8 Dimensions

All dimensions are given in millimeters and have a general tolerance according to DIN ISO 2768 - m.

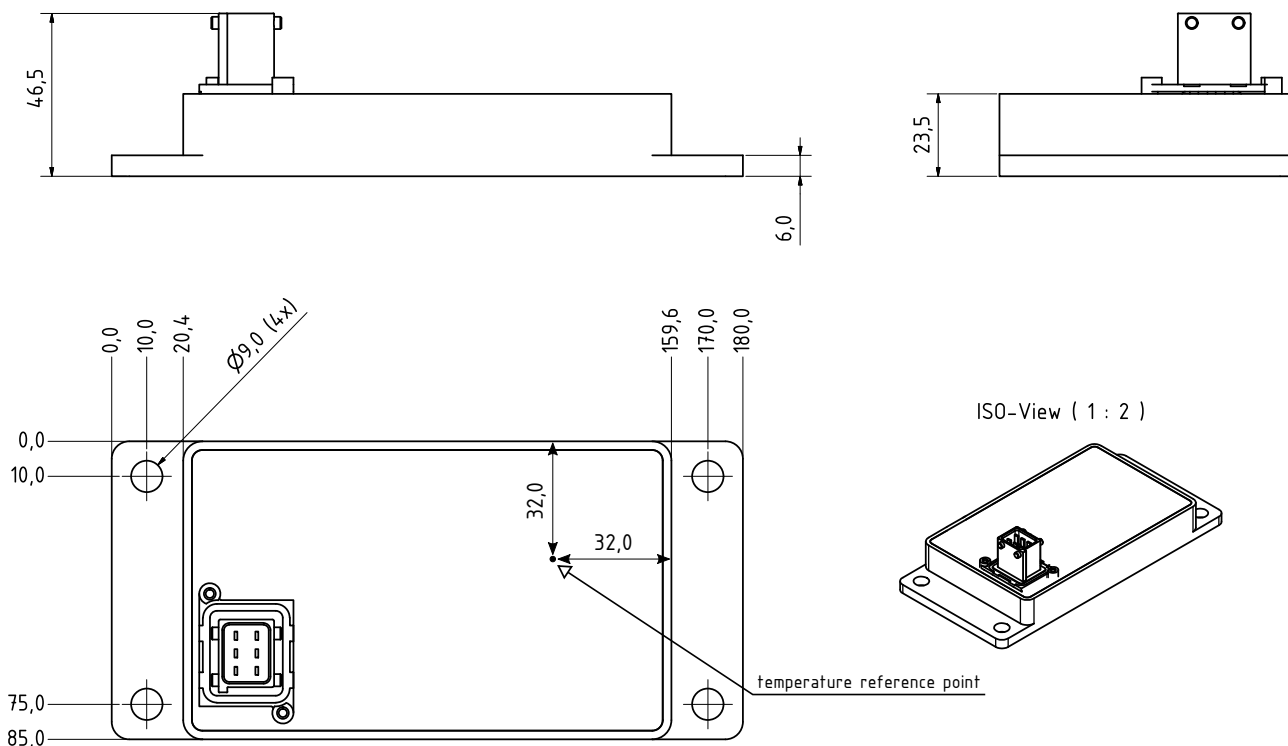

Figure 8.1: Dimensions

DC/DC converter

DVC153

Alle Daten gemessen bei 36, 48, 80VDC, 11, 12A und 25°C Umgebungstemperatur, wenn nicht anders gekennzeichnet. | All parameters are specified at 36, 48, 80VDC, 11, 12A and 25°C ambient, if not marked otherwise.

Technische Änderungen und Irrtümer vorbehalten. | Technical modifications and mistakes reserved.

Mit den Angaben im Katalog und in den Datenblättern werden Produkte beschrieben, nicht Eigenschaften zugesichert. Belastung mit „Grenzwerten“ (einfache Kombination) ist zulässig ohne bleibende Schäden der Produkte. Betrieb der Geräte mit Grenzwertbelastung für längere Zeit kann die Zuverlässigkeit beeinträchtigen. Grenzwerttoleranzen unterliegen üblichen Schwankungen. | Products are described by information contained in catalogs and data-sheets. It is not be considered as assured qualities. Stresses listed under „Maximum Rating“ (one at a time) may be applied to devices without resulting in permanent damage. The operation of the equipment for extended periods may affect device reliability. Limiting value tolerance are subject to usual fluctuation margins.

9 Characteristics

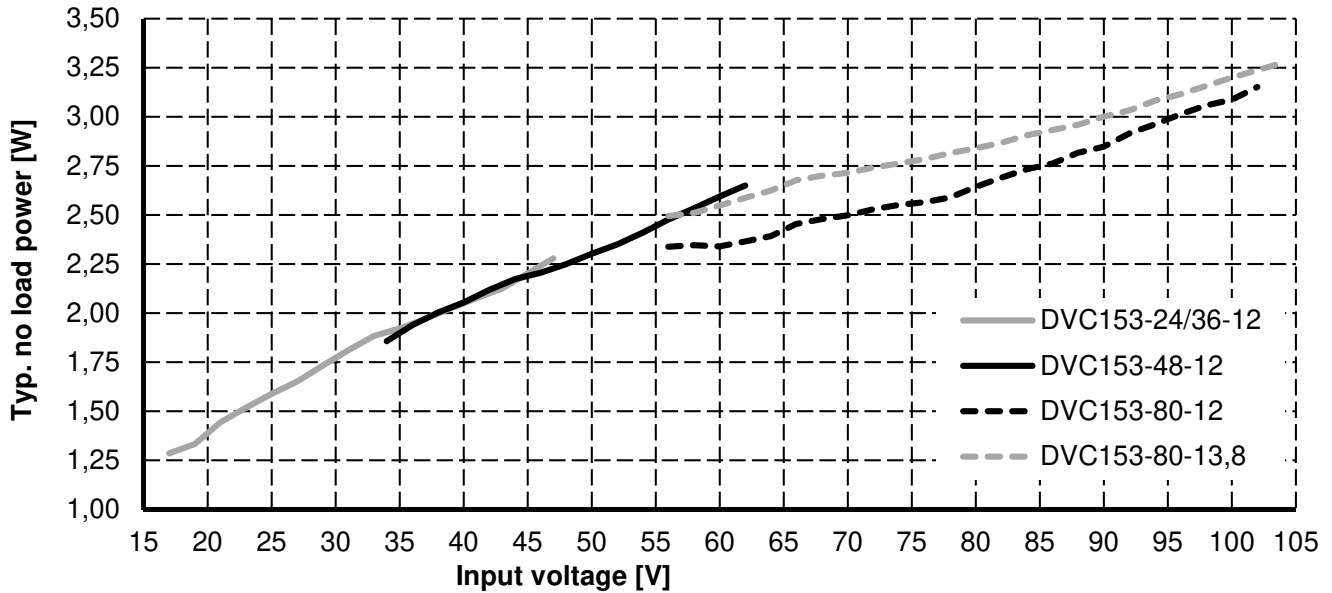

Figure 9.1: No-load power depending on the input voltage

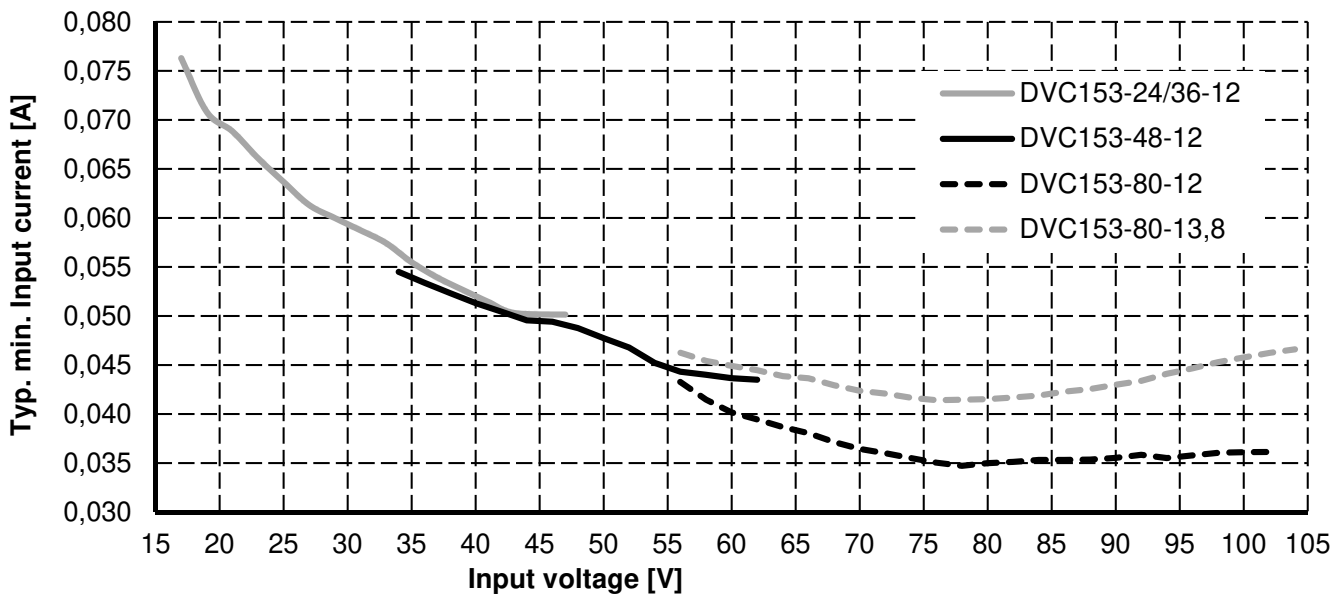

Figure 9.2: No load current consumption depending on the input voltage

DC/DC converter

DVC153

Alle Daten gemessen bei 36, 48, 80VDC, 11, 12A und 25°C Umgebungstemperatur, wenn nicht anders gekennzeichnet. | All parameters are specified at 36, 48, 80VDC, 11, 12A and 25°C ambient, if not marked otherwise.
 Technische Änderungen und Irrtümer vorbehalten. | Technical modifications and mistakes reserved.

Mit den Angaben im Katalog und in den Datenblättern werden Produkte beschrieben, nicht Eigenschaften zugesichert. Belastung mit „Grenzwerten“ (einfache Kombination) ist zulässig ohne bleibende Schäden der Produkte. Betrieb der Geräte mit Grenzwertbelastung für längere Zeit kann die Zuverlässigkeit beeinträchtigen. Grenzwerttoleranzen unterliegen üblichen Schwankungen. | Products are described by information contained in catalogs and data-sheets. It is not considered as assured qualities. Stresses listed under „Maximum Rating“ (one at a time) may be applied to devices without resulting in permanent damage. The operation of the equipment for extended periods may affect device reliability. Limiting value tolerance are subject to usual fluctuation margins.

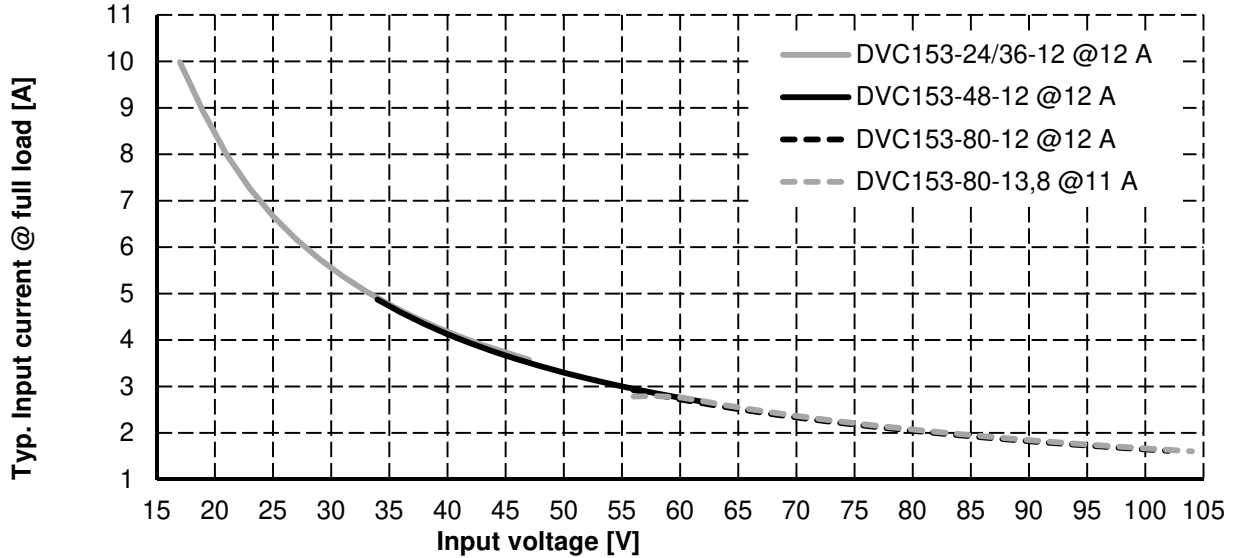

Figure 9.3: Current consumption at full load depending on the input voltage

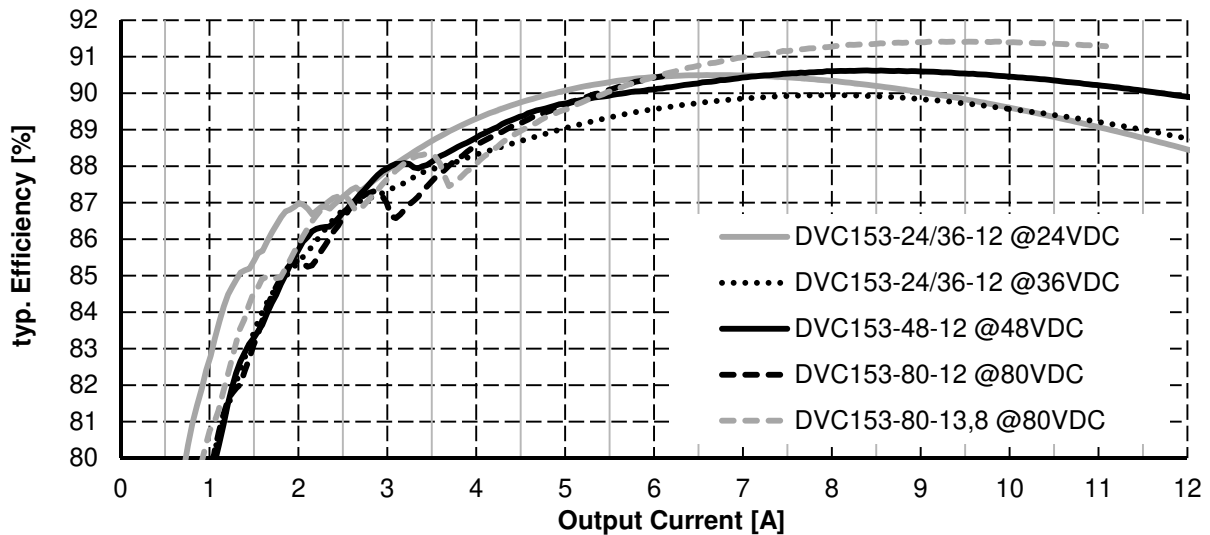

Figure 9.4: Efficiency depending on the output current

DC/DC converter

DVC153

Alle Daten gemessen bei 36, 48, 80VDC, 11, 12A und 25°C Umgebungstemperatur, wenn nicht anders gekennzeichnet. | All parameters are specified at 36, 48, 80VDC, 11, 12A and 25°C ambient, if not marked otherwise.

Technische Änderungen und Irrtümer vorbehalten. | Technical modifications and mistakes reserved.

Mit den Angaben im Katalog und in den Datenblättern werden Produkte beschrieben, nicht Eigenschaften zugesichert. Belastung mit „Grenzwerten“ (einfache Kombination) ist zulässig ohne bleibende Schäden der Produkte. Betrieb der Geräte mit Grenzwertbelastung für längere Zeit kann die Zuverlässigkeit beeinträchtigen. Grenzwerttoleranzen unterliegen üblichen Schwankungen. | Products are described by information contained in catalogs and data-sheets. It is not be considered as assured qualities. Stresses listed under „Maximum Rating“ (one at a time) may be applied to devices without resulting in permanent damage. The operation of the equipment for extended periods may affect device reliability. Limiting value tolerance are subject to usual fluctuation margins.

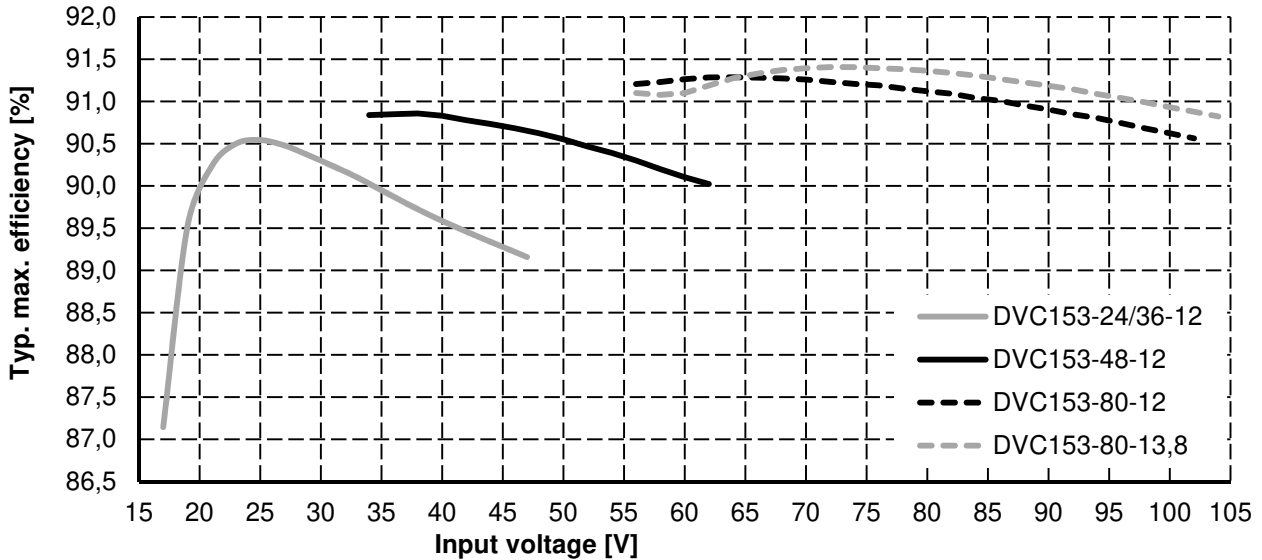

Figure 9.5: Max. efficiency depending on the input voltage

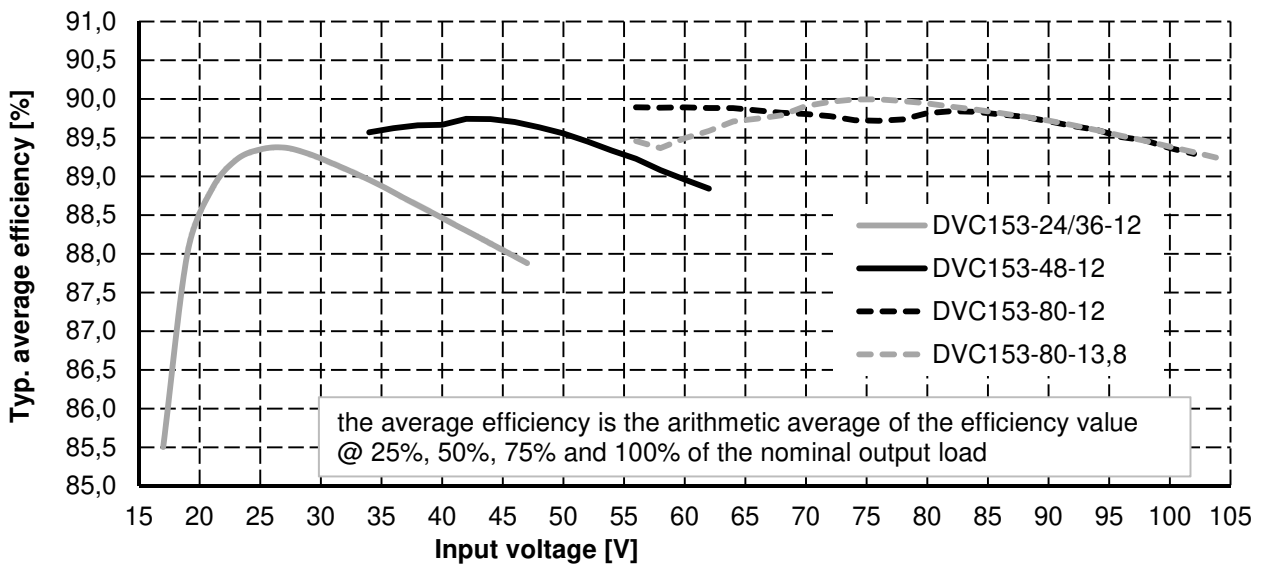

Figure 9.6: Average efficiency depending on the input voltage

DC/DC converter

DVC153

Alle Daten gemessen bei 36, 48, 80VDC, 11, 12A und 25°C Umgebungstemperatur, wenn nicht anders gekennzeichnet. | All parameters are specified at 36, 48, 80VDC, 11, 12A and 25°C ambient, if not marked otherwise.

Technische Änderungen und Irrtümer vorbehalten. | Technical modifications and mistakes reserved.

Mit den Angaben im Katalog und in den Datenblättern werden Produkte beschrieben, nicht Eigenschaften zugesichert. Belastung mit „Grenzwerten“ (einfache Kombination) ist zulässig ohne bleibende Schäden der Produkte. Betrieb der Geräte mit Grenzwertbelastung für längere Zeit kann die Zuverlässigkeit beeinträchtigen. Grenzwerttoleranzen unterliegen üblichen Schwankungen. | Products are described by information contained in catalogs and data-sheets. It is not considered as assured qualities. Stresses listed under „Maximum Rating“ (one at a time) may be applied to devices without resulting in permanent damage. The operation of the equipment for extended periods may affect device reliability. Limiting value tolerance are subject to usual fluctuation margins.

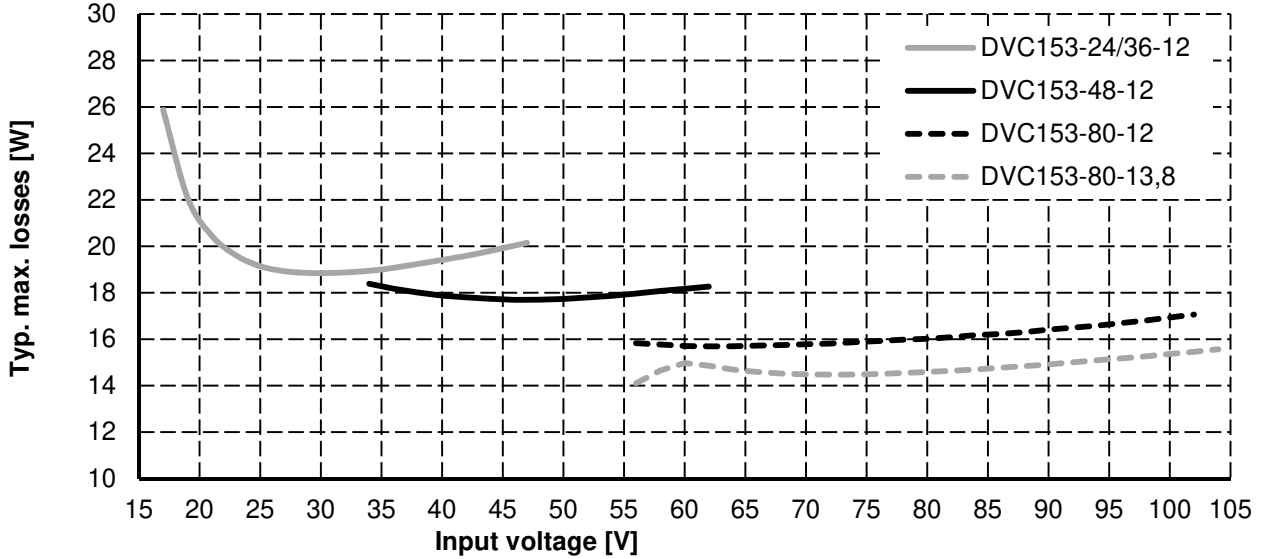

Figure 9.7: Typ. maximum power loss depending on the input voltage

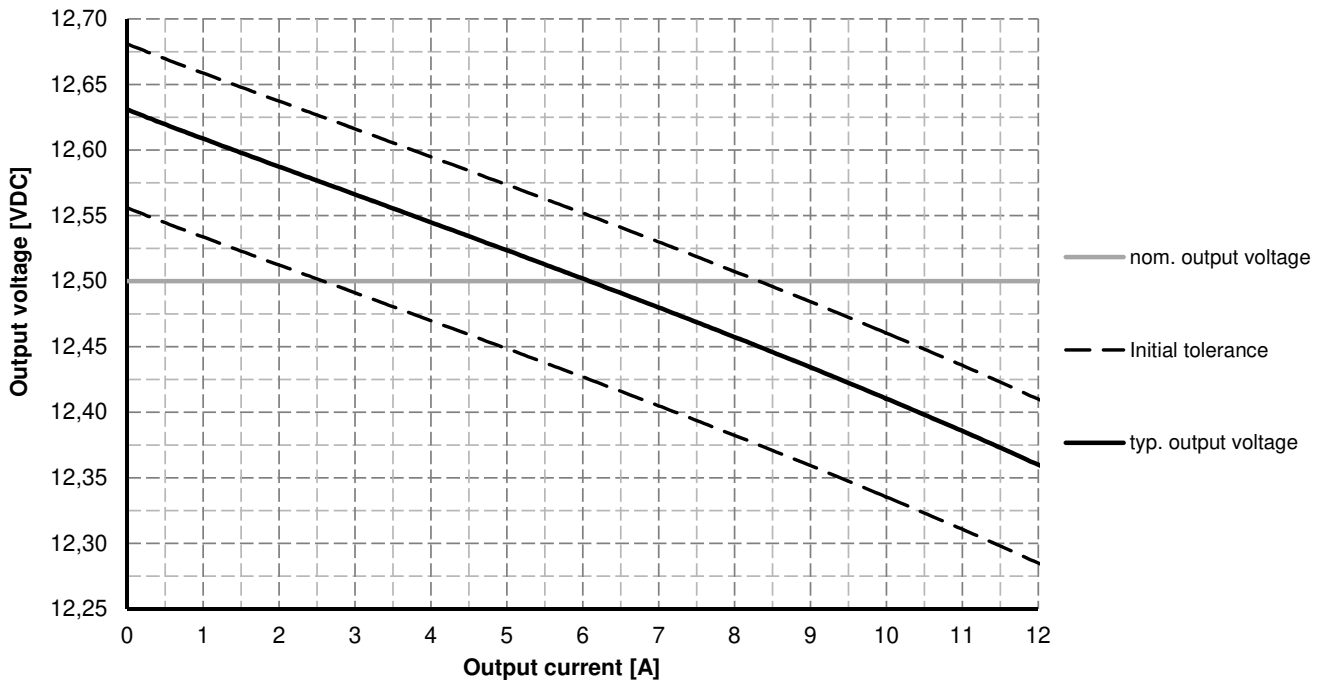

Figure 9.8: Typ. output voltage and initial tolerance ($U_{nom}=12,5$ VDC)

DC/DC converter

DVC153

Alle Daten gemessen bei 36, 48, 80VDC, 11, 12A und 25°C Umgebungstemperatur, wenn nicht anders gekennzeichnet. | All parameters are specified at 36, 48, 80VDC, 11, 12A and 25°C ambient, if not marked otherwise.
 Technische Änderungen und Irrtümer vorbehalten. | Technical modifications and mistakes reserved.

Mit den Angaben im Katalog und in den Datenblättern werden Produkte beschrieben, nicht Eigenschaften zugesichert. Belastung mit „Grenzwerten“ (einfache Kombination) ist zulässig ohne bleibende Schäden der Produkte. Betrieb der Geräte mit Grenzwertbelastung für längere Zeit kann die Zuverlässigkeit beeinträchtigen. Grenzwerttoleranzen unterliegen üblichen Schwankungen. | Products are described by information contained in catalogs and data-sheets. It is not be considered as assured qualities. Stresses listed under „Maximum Rating“ (one at a time) may be applied to devices without resulting in permanent damage. The operation of the equipment for extended periods may affect device reliability. Limiting value tolerance are subject to usual fluctuation margins.

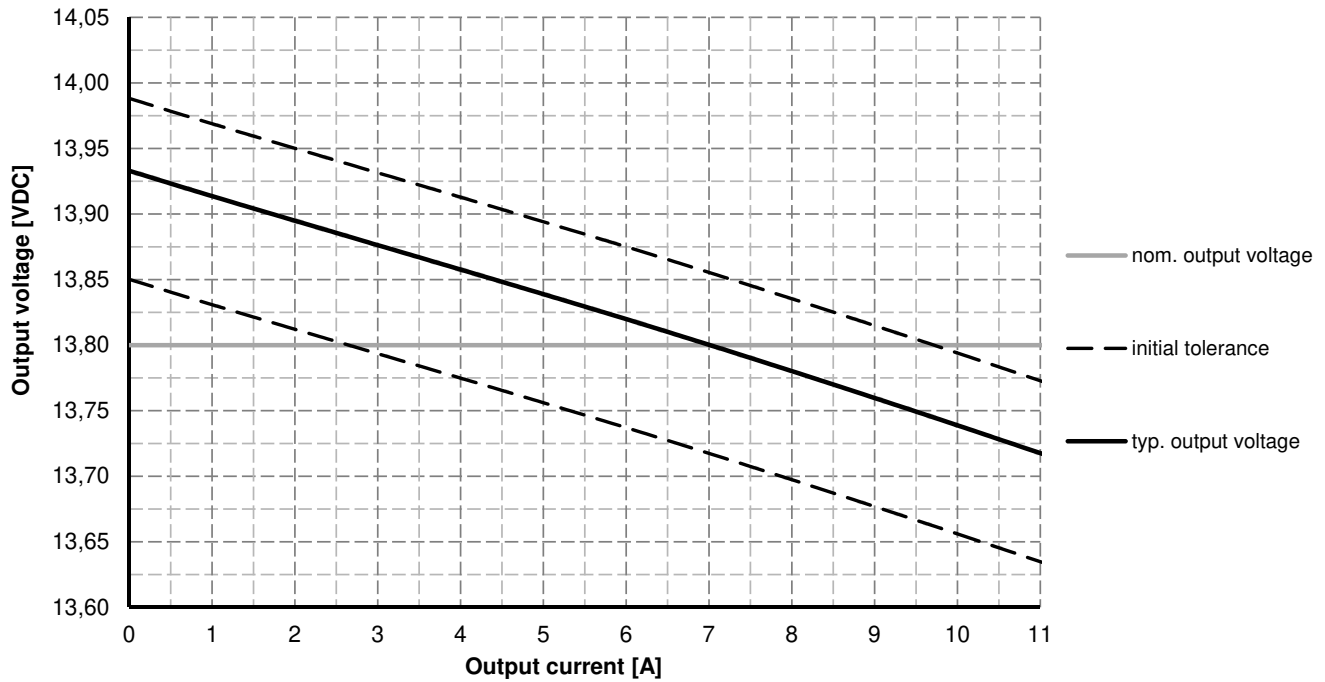

Figure 9.9: Typ. output voltage and initial tolerance ($U_{nom}=13,8$ VDC)

DC/DC converter

DVC153

Alle Daten gemessen bei 36, 48, 80VDC, 11, 12A und 25°C Umgebungstemperatur, wenn nicht anders gekennzeichnet. | All parameters are specified at 36, 48, 80VDC, 11, 12A and 25°C ambient, if not marked otherwise.
 Technische Änderungen und Irrtümer vorbehalten. | Technical modifications and mistakes reserved.

Mit den Angaben im Katalog und in den Datenblättern werden Produkte beschrieben, nicht Eigenschaften zugesichert. Belastung mit „Grenzwerten“ (einfache Kombination) ist zulässig ohne bleibende Schäden der Produkte. Betrieb der Geräte mit Grenzwertbelastung für längere Zeit kann die Zuverlässigkeit beeinträchtigen. Grenzwerttoleranzen unterliegen üblichen Schwankungen. | Products are described by information contained in catalogs and data-sheets. It is not be considered as assured qualities. Stresses listed under „Maximum Rating“ (one at a time) may be applied to devices without resulting in permanent damage. The operation of the equipment for extended periods may affect device reliability. Limiting value tolerance are subject to usual fluctuation margins.