

DVC1903

DC/DC converter



Abbildung ähnlich / device similar to figure



DVC1903-derivate table

Type	Input voltage		Output voltage	Output current		Cat. No.
	Nom.	Tol.	Nom.	Continuous	Boost*	
DVC1903-48/80-24	48 - 80 VDC	24 - 110 VDC	24,3 VDC	70 A	160 A	105216/0/000

*For max. 4s with subsequent recovery time of > 16s

DC/DC converter

DVC1903

Alle Daten gemessen bei 48/80DC, 70A und 25°C Umgebungstemperatur, wenn nicht anders gekennzeichnet. | All parameters are specified at 48/80DC, 70A and 25°C ambient, if not marked otherwise.
 Technische Änderungen und Irrtümer vorbehalten. | Technical modifications and mistakes reserved.

Mit den Angaben im Katalog und in den Datenblättern werden Produkte beschrieben, nicht Eigenschaften zugesichert. Belastung mit „Grenzwerten“ (einfache Kombination) ist zulässig ohne bleibende Schäden der Produkte. Betrieb der Geräte mit Grenzwertbelastung für längere Zeit kann die Zuverlässigkeit beeinträchtigen. Grenzwerttoleranzen unterliegen üblichen Schwankungen. | Products are described by information contained in catalogs and data-sheets. It is not be considered as assured qualities. Stresses listed under „Maximum Rating“ (one at a time) may be applied to devices without resulting in permanent damage. The operation of the equipment for extended periods may affect device reliability. Limiting value tolerance are subject to usual fluctuation margins.

1 Input

Input voltage range	-	see DVC1903-derivate table on page 1 (valid for continuous operation)
Undervoltage range	0 - 24 VDC	Class C*
Lower restricted operation range	24 - 34 VDC	Continuous operation, class B*
Unrestricted operation range	34 - 110 VDC	Continuous operation, class A*
Upper restricted operation range	110 - 112 VDC	≤ 5 s, class B*
Overvoltage range	112 - 120 VDC	≤ 100 ms, class C*
Start up delay	typ. 1,8 s	-
Max. current consumption	< 55 A (cont.) < 125 A (boost)	see fig. 8.3
Input capacity	approx. 19 µF	Attention: No inrush current limitation in the device. Provide precharge section in the application.
No-load current consumption	< 180 mA	see fig. 8.2
No-load power	< 6 W	see fig. 8.1

* Evaluation criteria for the operation behavior

The following evaluation criteria describe the functional state of the DC/DC converter as a function of the operation input voltage.

Class A	Unrestricted operation range	The DC/DC converter operates as designed in compliance with the tolerances specified in the data sheet.
Class B	Lower and upper restricted operation range	One or more functions may go beyond the specified tolerance. After returning to the unrestricted operation range, the DC/DC converter operates again as designed.
Class C	Undervoltage and overvoltage range	One or more functions do not work as intended. After returning to the unrestricted operation range, the DC/DC converter operates again as designed.

2 Output

Output voltage U_{nom}	-	see DVC1903-derivate table on page 1 (valid for continuous operation)
Initial tolerance $N_{initial}$	$U_{nom} \pm 1,5\%$	see fig. 8.7
load regulation tolerance N_{load}	$U_{nom} + 0,1\% / - 0,5\%$	-
Overall tolerance $N_{overall}$	$U_{nom} + 1,6\% / - 2,0\%$	$N_{overall} = N_{initial} + N_{load}$
Overall tolerance $N_{0-20\text{ Hz}}$	$U_{nom} + 2,8\% / - 3,2\%$	$N_{0-20\text{ Hz}} = N_{initial} + N_{load} + \text{Ripple \& Noise}$
Max. continuous output current I_{nom}	70 A	-
Max. shortterm output current I_{boost}	160 A	for $t_{boost} \leq 4\text{ s}$ with subsequent recovery phase $t_{pause} \geq 16\text{ s}$
Max. continuous output power P_{nom}	$\leq 1680\text{ W}$	-
Max. shortterm output power P_{boost}	$\leq 3840\text{ W}$	for $t_{boost} \leq 4\text{ s}$ with subsequent recovery phase $t_{pause} \geq 16\text{ s}$
Current limiting	$< I_{max} + 10\%$	Depending on the device status, I_{max} can correspond to the nominal current I_{nom} or the boost current I_{boost} . From $1.0 \times I_{max}$ U_{out} can drop
recovery time	$< 3\text{ ms}$	Duration from leaving the overall tolerance until the permanently return to the tolerance band after a load step
Ripple & Noise	typ. $< 600\text{ mV}_{pp}$	measurement bandwidth = 20 MHz, $I_{out} = 0 - 160\text{ A}$

3 Environment

Working temperature (environment)	-40°C ... +75°C	-
Max. permissible temperature of the mounting surface	< +50°C	-
Overtemperature protection	+95°C	Automatic switch-off in case of overtemperature. On request: Automatic power derating in case of overtemperature.
Storage temperature	-40°C ... +85°C	-
Humidity	< 95%	-
Dewing	allowed	-
Shock test acc. to DIN EN 60068-2-27	-	half sinusoidal (Excitation) 250m/s ² (Peak acceleration) 6ms (Duration) 3.000 shocks to each axis (Quantity) ±X, ±Y, ±Z (Axis)
Vibration test acc. to DIN EN 60068-2-6	-	sinusoidal (Excitation) 30m/s ² (acceleration) 10 - 500Hz (frequency, floating) 2h per axis (Duration), 1 Oct/min X, Y, Z (Axis)
Degree of protection acc. to EN60529	IP54	Limited by connection technology, version with increased degree of protection and other connection technology on request

4 General data

Insulation strength	1 kVDC 1 kVDC	Input / Enclosure Input / Output
Max. efficiency	typ. 95,0% (48 VDC) typ. 94,1% (80 VDC)	see fig. 8.5
Average efficiency	typ. 94,6% (48 VDC) typ. 93,5% (80 VDC)	Averaging of the efficiency values at 25%, 50%, 75% and 100% of the nominal output power.
Dimensions (LxWxH)	210 x 189 x 21,5 mm	without connections, see fig. 7.1
Enclosure	Aluminium	-
Weight	approx 1,8 kg	-

DC/DC converter

DVC1903

Alle Daten gemessen bei 48/80DC, 70A und 25°C Umgebungstemperatur, wenn nicht anders gekennzeichnet. | All parameters are specified at 48/80DC, 70A and 25°C ambient, if not marked otherwise.
 Technische Änderungen und Irrtümer vorbehalten. | Technical modifications and mistakes reserved.

Mit den Angaben im Katalog und in den Datenblättern werden Produkte beschrieben, nicht Eigenschaften zugesichert. Belastung mit „Grenzwerten“ (einfache Kombination) ist zulässig ohne bleibende Schäden der Produkte. Betrieb der Geräte mit Grenzwertbelastung für längere Zeit kann die Zuverlässigkeit beeinträchtigen. Grenzwerttoleranzen unterliegen üblichen Schwankungen. | Products are described by information contained in catalogs and data-sheets. It is not be considered as assured qualities. Stresses listed under „Maximum Rating“ (one at a time) may be applied to devices without resulting in permanent damage. The operation of the equipment for extended periods may affect device reliability. Limiting value tolerance are subject to usual fluctuation margins.

5 Standards

EMC (Electromagnetic Compatibility)

Title	Standard	Data
Emitted interference	EN12895 EN61204-3	- according to 6.4.2, Table H.3, for residential, commercial and light industrial environments (Class B, cable length < 3 m)
Immunity	EN12895 EN61204-3	- according to 7.2.3: Immunity level for industrial environment (cable length < 3 m)

Electrical safety

Title	Standard	Data
Low-voltage switch mode power supplies - Safety requirements	DIN EN 61204-7	-
Safety of industrial trucks - Electrical requirements	designed according to DIN EN 1175*	-

* The system integrator is responsible for compliance of all product-specific requirements in the end application.

6 Installation and safety instructions

In addition to the general installation and safety instructions for DC/DC converters, the following values and supplements apply:

Mounting points	-	10x Mounting holes (Ø6,5 mm) see fig. 7.1
Installation orientation	-	any
Connection input	+U _{in} (M8) / -U _{in} (M8)	Tightening torque: 9 Nm Thread depth: 8 mm Recommended cable cross section: 16 mm ²
Connection output	+U _{out} (M8) / -U _{out} (M8)	Tightening torque: 9 Nm Thread depth: 8 mm Recommended cable cross section: 25 mm ²
Input fuse	-	No integrated input fuse. A fuse must be provided externally by the customer application.
Reverse polarity protection	-	No reverse polarity protection at the input or output of the device. If the polarity is reversed at the input, the input fuse to be connected in series is tripped.
Precharge section	-	Attention: No inrush current limitation in the device. Provide precharge section in the application.

DC/DC converter

DVC1903

Alle Daten gemessen bei 48/80DC, 70A und 25°C Umgebungstemperatur, wenn nicht anders gekennzeichnet. | All parameters are specified at 48/80DC, 70A and 25°C ambient, if not marked otherwise.
Technische Änderungen und Irrtümer vorbehalten. | Technical modifications and mistakes reserved.

Mit den Angaben im Katalog und in den Datenblättern werden Produkte beschrieben, nicht Eigenschaften zugesichert. Belastung mit „Grenzwerten“ (einfache Kombination) ist zulässig ohne bleibende Schäden der Produkte. Betrieb der Geräte mit Grenzwertbelastung für längere Zeit kann die Zuverlässigkeit beeinträchtigen. Grenzwerttoleranzen unterliegen üblichen Schwankungen. | Products are described by information contained in catalogs and data-sheets. It is not be considered as assured qualities. Stresses listed under „Maximum Rating“ (one at a time) may be applied to devices without resulting in permanent damage. The operation of the equipment for extended periods may affect device reliability. Limiting value tolerance are subject to usual fluctuation margins.

The general installation and safety instructions for DC/DC converters can be found at: www.deutronic.com

7 Dimensions

All dimensions are given in millimeters and have a general tolerance according to DIN ISO 2768 - m.

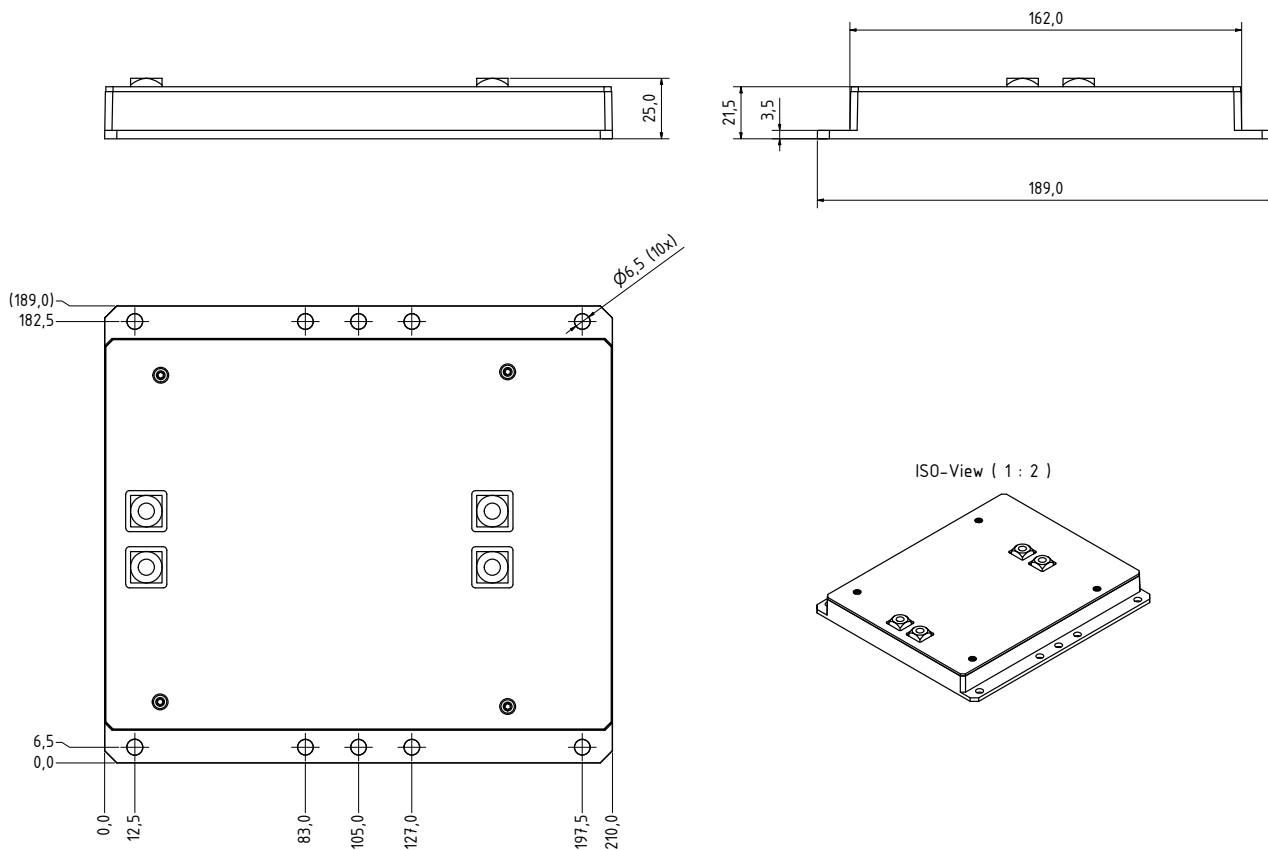

Figure 7.1: Dimensions

DC/DC converter

DVC1903

Alle Daten gemessen bei 48/80DC, 70A und 25°C Umgebungstemperatur, wenn nicht anders gekennzeichnet. | All parameters are specified at 48/80DC, 70A and 25°C ambient, if not marked otherwise.
 Technische Änderungen und Irrtümer vorbehalten. | Technical modifications and mistakes reserved.

Mit den Angaben im Katalog und in den Datenblättern werden Produkte beschrieben, nicht Eigenschaften zugesichert. Belastung mit „Grenzwerten“ (einfache Kombination) ist zulässig ohne bleibende Schäden der Produkte. Betrieb der Geräte mit Grenzwertbelastung für längere Zeit kann die Zuverlässigkeit beeinträchtigen. Grenzwerttoleranzen unterliegen üblichen Schwankungen. | Products are described by information contained in catalogs and data-sheets. It is not be considered as assured qualities. Stresses listed under „Maximum Rating“ (one at a time) may be applied to devices without resulting in permanent damage. The operation of the equipment for extended periods may affect device reliability. Limiting value tolerance are subject to usual fluctuation margins.

8 Characteristics

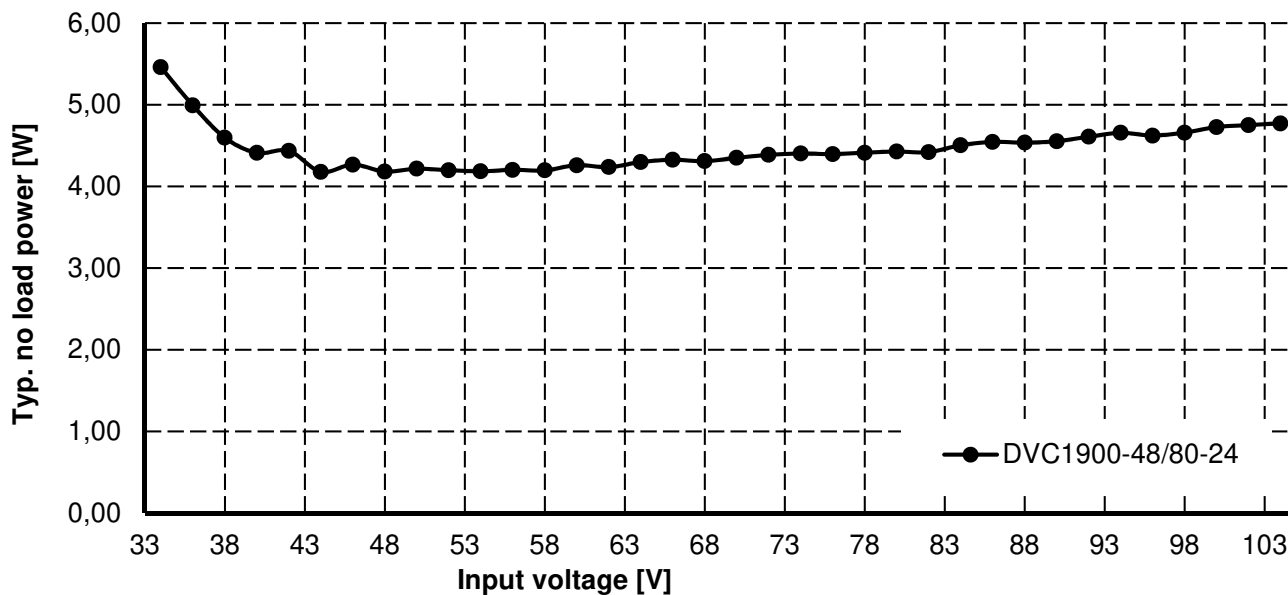

Figure 8.1: No-load power

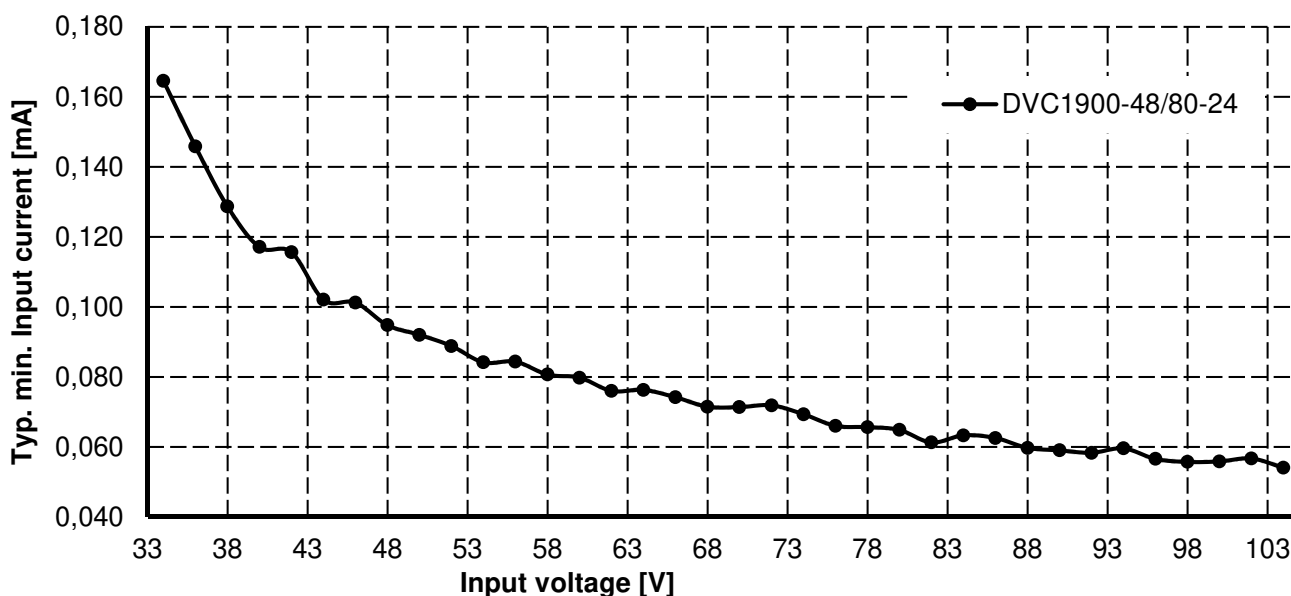

Figure 8.2: No load input current

DC/DC converter

DVC1903

Alle Daten gemessen bei 48/80DC, 70A und 25°C Umgebungstemperatur, wenn nicht anders gekennzeichnet. | All parameters are specified at 48/80DC, 70A and 25°C ambient, if not marked otherwise.
 Technische Änderungen und Irrtümer vorbehalten. | Technical modifications and mistakes reserved.

Mit den Angaben im Katalog und in den Datenblättern werden Produkte beschrieben, nicht Eigenschaften zugesichert. Belastung mit „Grenzwerten“ (einfache Kombination) ist zulässig ohne bleibende Schäden der Produkte. Betrieb der Geräte mit Grenzwertbelastung für längere Zeit kann die Zuverlässigkeit beeinträchtigen. Grenzwerttoleranzen unterliegen üblichen Schwankungen. | Products are described by information contained in catalogs and data-sheets. It is not be considered as assured qualities. Stresses listed under „Maximum Rating“ (one at a time) may be applied to devices without resulting in permanent damage. The operation of the equipment for extended periods may affect device reliability. Limiting value tolerance are subject to usual fluctuation margins.

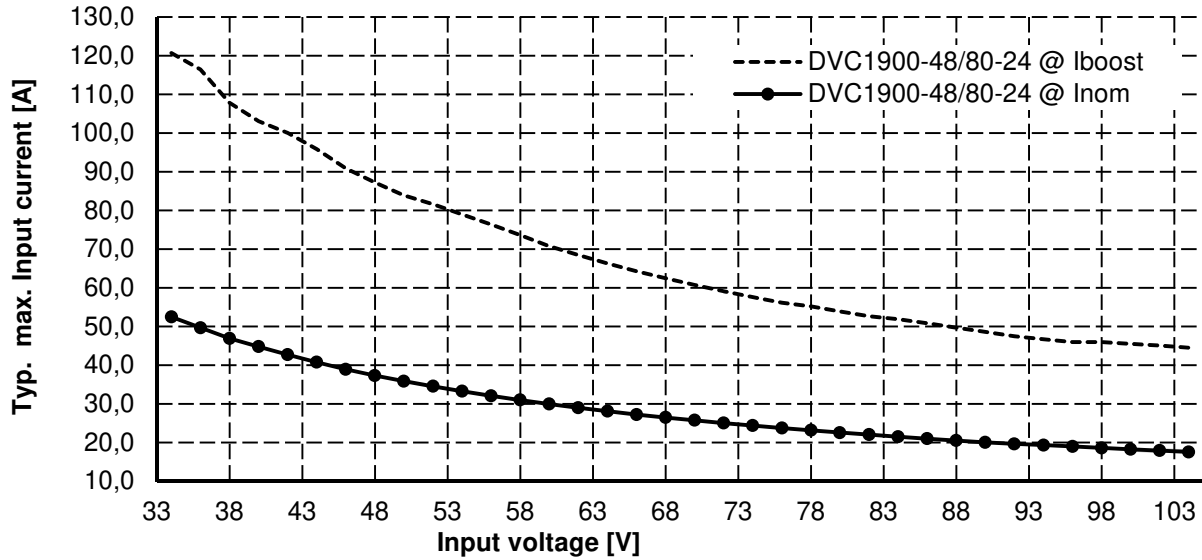

Figure 8.3: Current consumption depending on the output power

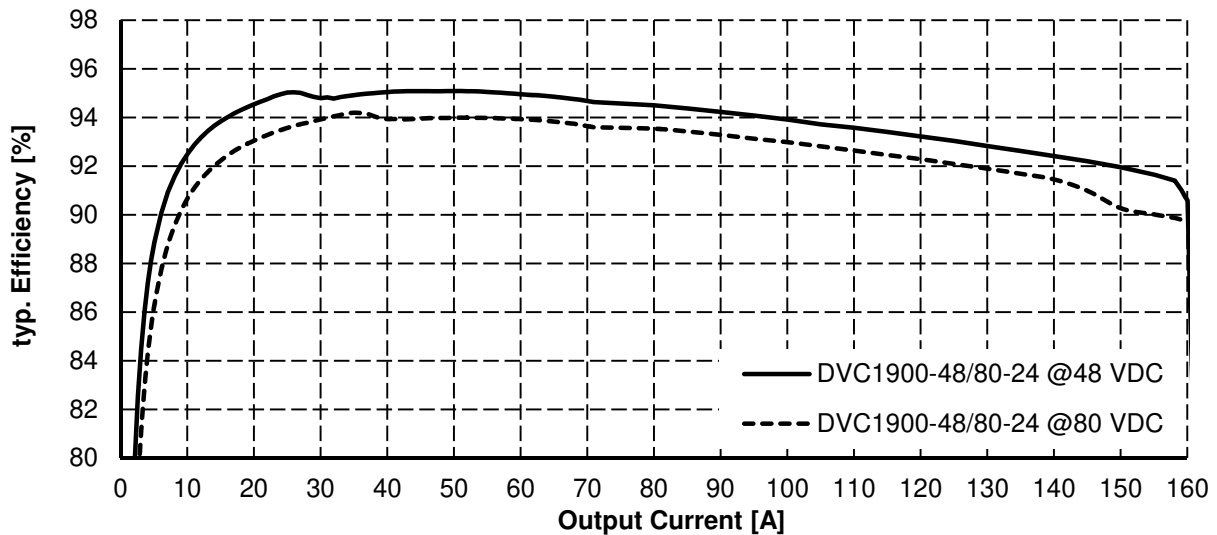

Figure 8.4: Efficiency depending on the output current

DC/DC converter

DVC1903

Alle Daten gemessen bei 48/80DC, 70A und 25°C Umgebungstemperatur, wenn nicht anders gekennzeichnet. | All parameters are specified at 48/80DC, 70A and 25°C ambient, if not marked otherwise.
 Technische Änderungen und Irrtümer vorbehalten. | Technical modifications and mistakes reserved.

Mit den Angaben im Katalog und in den Datenblättern werden Produkte beschrieben, nicht Eigenschaften zugesichert. Belastung mit „Grenzwerten“ (einfache Kombination) ist zulässig ohne bleibende Schäden der Produkte. Betrieb der Geräte mit Grenzwertbelastung für längere Zeit kann die Zuverlässigkeit beeinträchtigen. Grenzwerttoleranzen unterliegen üblichen Schwankungen. | Products are described by information contained in catalogs and data-sheets. It is not considered as assured qualities. Stresses listed under „Maximum Rating“ (one at a time) may be applied to devices without resulting in permanent damage. The operation of the equipment for extended periods may affect device reliability. Limiting value tolerance are subject to usual fluctuation margins.

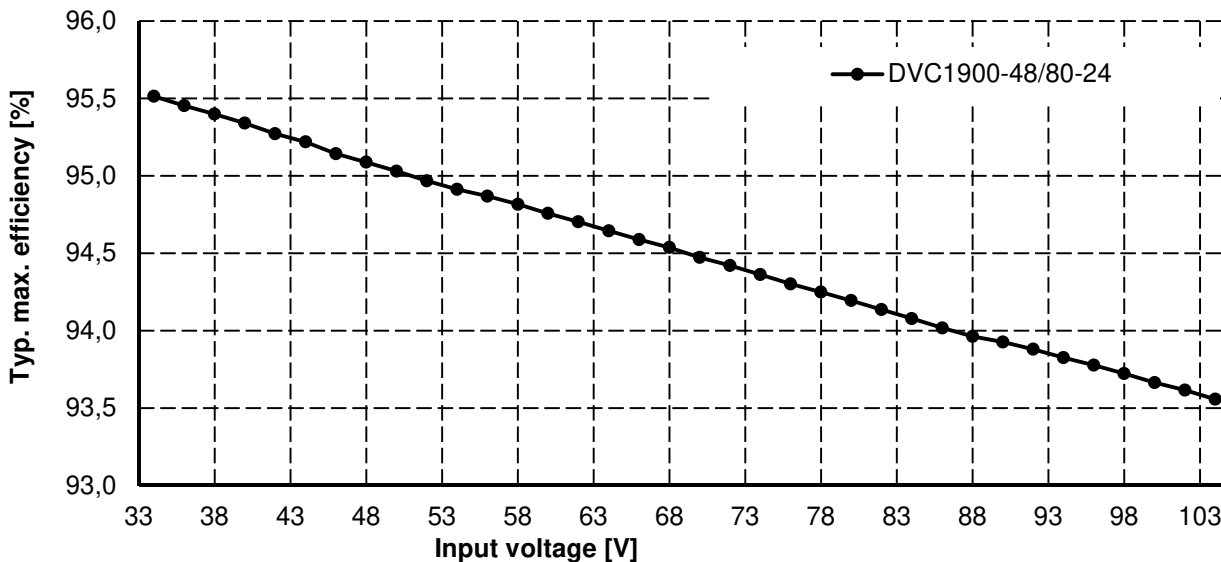

Figure 8.5: Max. efficiency depending on the input voltage

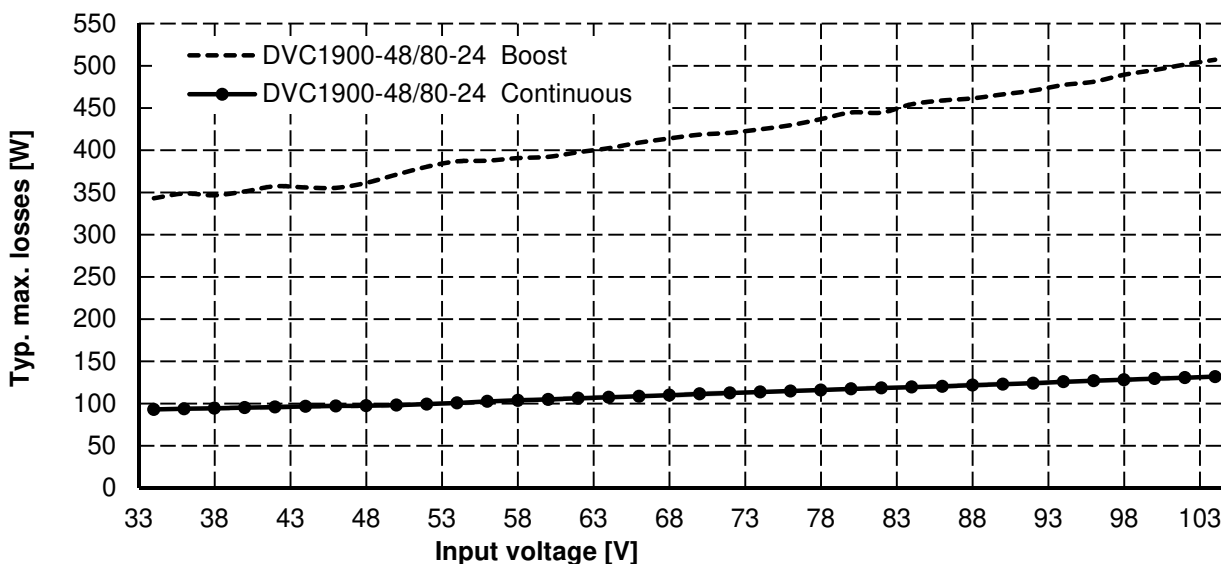

Figure 8.6: Typ. maximum power loss

DC/DC converter

DVC1903

Alle Daten gemessen bei 48/80DC, 70A und 25°C Umgebungstemperatur, wenn nicht anders gekennzeichnet. | All parameters are specified at 48/80DC, 70A and 25°C ambient, if not marked otherwise.
 Technische Änderungen und Irrtümer vorbehalten. | Technical modifications and mistakes reserved.

Mit den Angaben im Katalog und in den Datenblättern werden Produkte beschrieben, nicht Eigenschaften zugesichert. Belastung mit „Grenzwerten“ (einfache Kombination) ist zulässig ohne bleibende Schäden der Produkte. Betrieb der Geräte mit Grenzwertbelastung für längere Zeit kann die Zuverlässigkeit beeinträchtigen. Grenzwerttoleranzen unterliegen üblichen Schwankungen. | Products are described by information contained in catalogs and data-sheets. It is not be considered as assured qualities. Stresses listed under „Maximum Rating“ (one at a time) may be applied to devices without resulting in permanent damage. The operation of the equipment for extended periods may affect device reliability. Limiting value tolerance are subject to usual fluctuation margins.

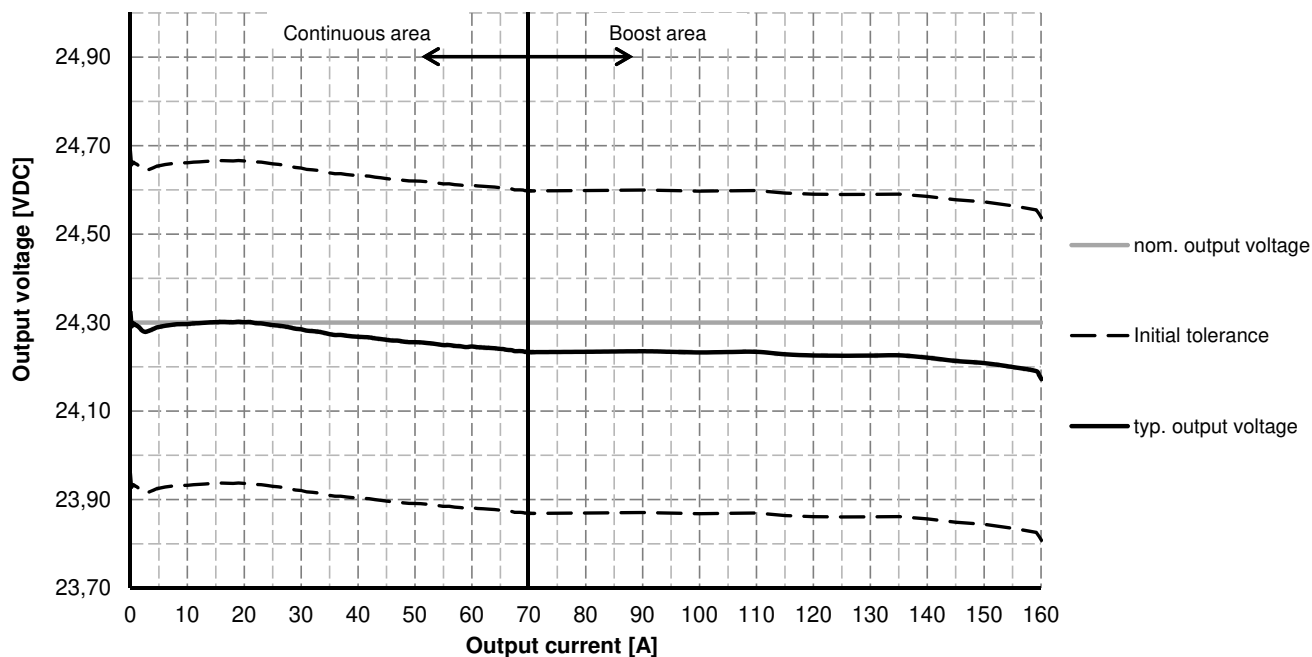

Figure 8.7: Typ. output voltage and initial tolerance

DC/DC converter

DVC1903

Alle Daten gemessen bei 48/80DC, 70A und 25°C Umgebungstemperatur, wenn nicht anders gekennzeichnet. | All parameters are specified at 48/80DC, 70A and 25°C ambient, if not marked otherwise.
 Technische Änderungen und Irrtümer vorbehalten. | Technical modifications and mistakes reserved.

Mit den Angaben im Katalog und in den Datenblättern werden Produkte beschrieben, nicht Eigenschaften zugesichert. Belastung mit „Grenzwerten“ (einfache Kombination) ist zulässig ohne bleibende Schäden der Produkte. Betrieb der Geräte mit Grenzwertbelastung für längere Zeit kann die Zuverlässigkeit beeinträchtigen. Grenzwerttoleranzen unterliegen üblichen Schwankungen. | Products are described by information contained in catalogs and data-sheets. It is not be considered as assured qualities. Stresses listed under „Maximum Rating“ (one at a time) may be applied to devices without resulting in permanent damage. The operation of the equipment for extended periods may affect device reliability. Limiting value tolerance are subject to usual fluctuation margins.